

MB

- ✓ Robust and silent
- ✓ Automatic search for the first trough
- ✓ Maximum respect for the dough's structure
- ✓ Compact
- ✓ Two trough sizes available
- ✓ Fitted with sockets to connect a moulder and divider

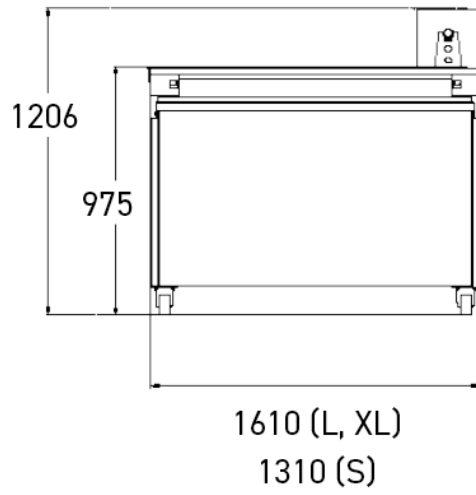

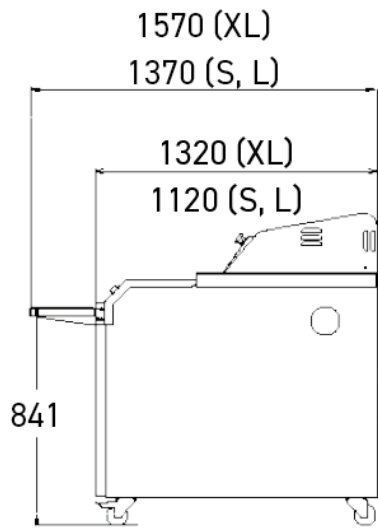

SPECIFICATIONS

Synthetic felt troughs		•	
Automatic search for the first trough		•	
Motor power in kW		0.25	
		Standard troughs	Wide troughs
	Net weight (in kg)	260	260
	Maximum weight of dough pieces in grams	650	950
	Length/width of troughs in cm	136 x 14	136 x 16
	Total number of troughs	33	26
350 g* dough pieces	Number of dough pieces per trough	9	9
	Maximum capacity	297	234
550 g* dough pieces	Number of dough pieces per trough	8	8
	Maximum capacity	264	208
750 g* dough pieces	Number of dough pieces per trough	n/a	7
	Maximum capacity	n/a	182
950 g* dough pieces	Number of dough pieces per trough	n/a	6
	Maximum capacity	n/a	156

TECHNICAL SPECIFICATIONS

Power supply	230V Triphasé,400V Triphasé
Troughs	Standard, Large
Options (Additional cost)	Germicidal UV lamp with protection and air extractor, Folding rounding tray, Foot control, Synthetic fabric troughs, Silicone coated troughs, Pre-assembly in factory

MAIN STRENGTHS



Two three-phase power sockets

Facilitates the connection of moulder and divider.



Bronze ring gear wheel

Reduces friction and extends service life.

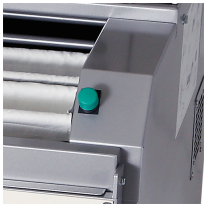

Controls (right/left)

Simple and ergonomic



Automatic search for the first trough

Ease of use and appreciable time savings. No more need for a prolonged button press by the operator to find the first loaded dough piece. With a press of a button, the machine will do it for you.