

# ZIP

- ✓ Speed of execution
- ✓ Maximum safety
- ✓ First-rate hygiene
- ✓ Stainless steel exterior
- ✓ Versatility

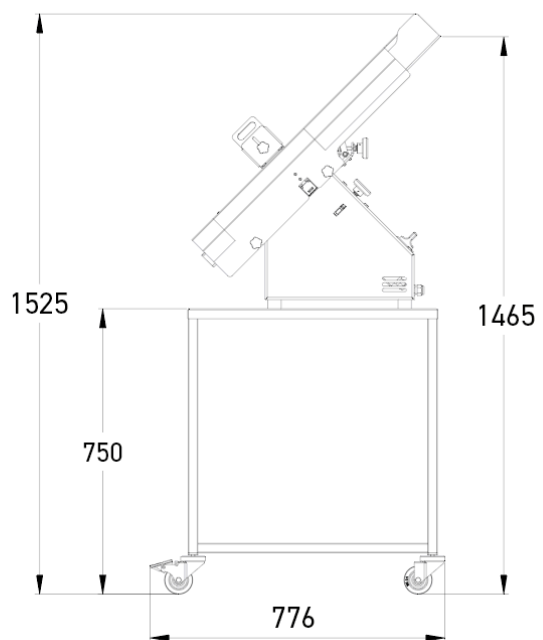
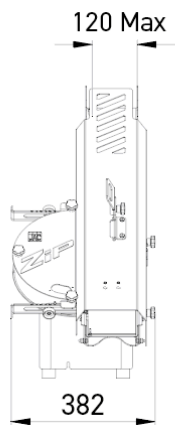
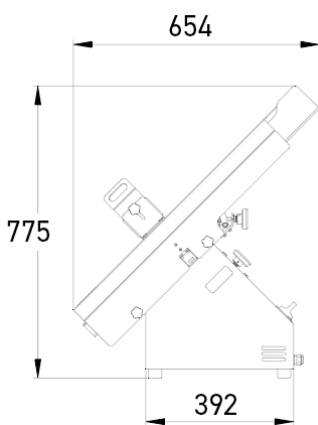

## SPECIFICATIONS

Max/min bread dimensions (W x H) in mm	60 x 40 / 120 x 80
Power supply	230V single phase
Motor power in kW	0.49
Net weight (in kg)	35
Blade type and dimensions in mm	300 mm diameter steel

## MAIN STRENGTHS



### Adjustable cutting tunnel

The adjustable height and width allow several types of loaves to be held, while ensuring a clean, precise cut.

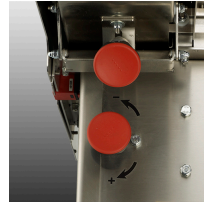

### Blade adjustment handle

To set the height and depth of the cut in the bread.



### Stainless steel shutter

Finger protection system fixed at the outlet of the cutting area.



### Fan

For better engine cooling during intensive use.